

KALFIRE

FIREPLACES

E-ONE 100 F

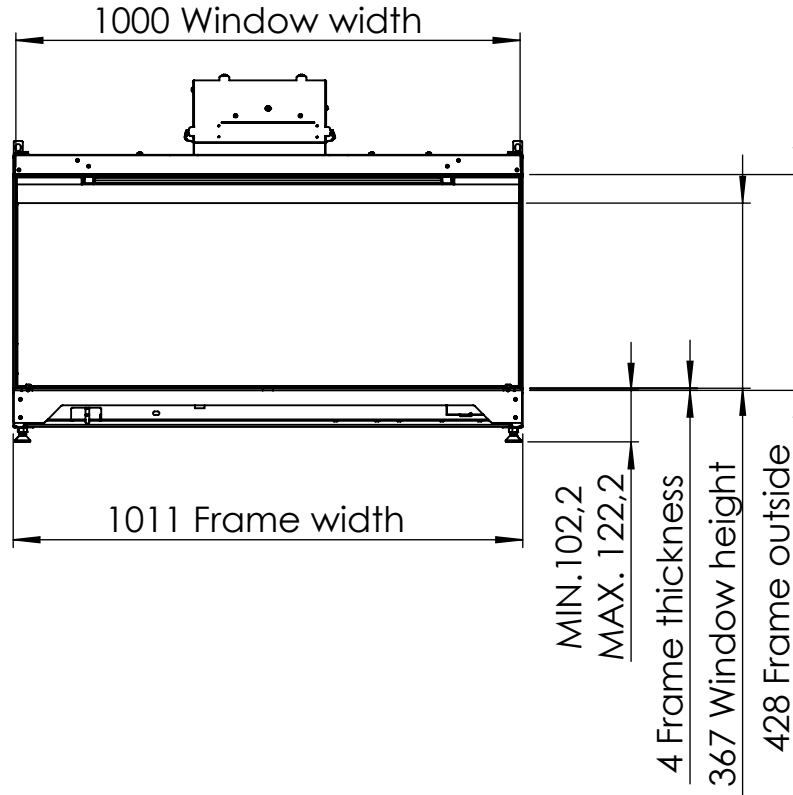
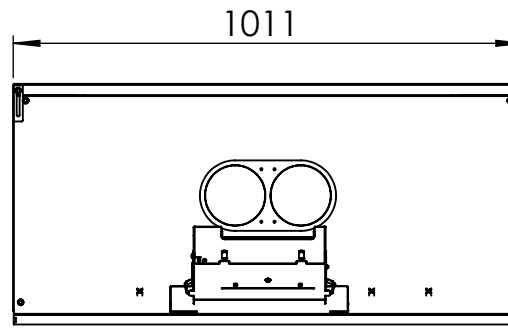
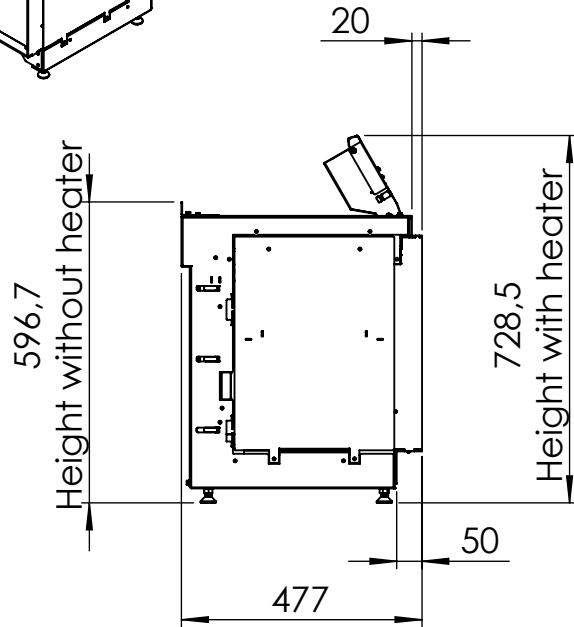
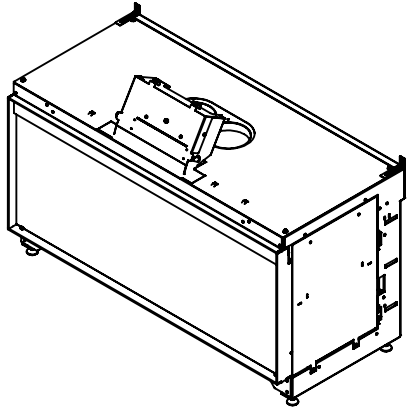

Note:

Minimum of 2mm clearance around frame.
 All materials must withstand a temperature of minimum 80 degrees.
 A minimum of 100 cm² of free area is required.
 Ventilation must be provided at both the bottom and top of the housing.
 No rights can be derived from this drawing.

All dimensions in mm. Modifications under reserve.

28-11-2024 sheet 1 / 1